

# CSB 99-6

TECHNICAL PORTIONS  
FAA APPROVED

## SUBJECT: GTSIO-520 & GIO-550 CRANKSHAFT INSPECTION

**BACKGROUND:** Teledyne Continental Motors (TCM) has become aware of one GTSIO-520 crankshaft fracture on an engine manufactured in 1998 similar in origin to the crankshaft fractures addressed in TCM MSB99-3B (formally CSB99-3A). The cause of the fractures, which have occurred in the eight straight drive engine crankshafts and the one GTSIO-520 crankshaft, have been identified as a discrepancy in the counterweight bushing installation process. These fractures have occurred in crankshafts that have been grouped around discreet manufacturing periods. Crankshaft fractures have occurred in engines with 45 to 340 hours of operation since new, factory rebuilt or field overhauled. TCM has implemented an inspection program that covers new and rebuilt geared engine crankshafts processed from January 1, 1998 through December 31, 1998. Review of the manufacturing processes, basic metallurgy, nitride characteristics, dimensional characteristics and supplier practices have not identified any other contributing causes.

**PURPOSE:** To provide instructions for the inspection of the number two, five and eight crankshaft cheeks of GTSIO-520 style crankshafts manufactured or rebuilt in 1998.

### WARNING

**Inspection is required since undetected cracks can lead to engine failure.**

The inspection requires the removal of three cylinders, three connecting rods and six counterweights to facilitate the visual and ultrasonic inspection of specific areas of the number two, five and eight crankshaft cheeks.

A TCM representative will perform all inspections. Call TCM at 1-888-200-7565 to schedule inspection of your aircraft engine crankshaft.

**COMPLIANCE:** For affected engines or crankshafts with 500 hours or less total time in service since new or rebuilt, this inspection must be performed within the next 10 hours of operation.

For affected engines or crankshafts with over 500 hours total time in service since new or rebuilt this inspection must be performed within the next 50 hours of operation or at the next scheduled maintenance event, whichever occurs first.

ISSUED			REVISED			 <b>TELEDYNE CONTINENTAL MOTORS</b> An Allegheny Teledyne Company P.O. Box 90 Mobile AL 36601 • 334-438-3411	PAGE NO	REVISION
MO	DAY	YEAR	MO	DAY	YEAR		1 of 13 CSB99-6	
07	06	1999						

© TELEDYNE INDUSTRIES, INC. 1999

Uninstalled service spare crankshafts of the affected serial number range must be inspected prior to installation in any engine in accordance with DETAILED INSPECTION, Section C, of this bulletin.

**ENGINES**

**AFFECTED:** Your engine is subject to this CSB if either of the following criteria is satisfied.

1. Your engine is a TCM GTSIO-520-C, D, F, G, H, K, L, M, N or GIO-550-A series New or Rebuilt engine and the engine crankshaft was processed by TCM during calendar year 1998. Specific engine models and serial numbers are provided in the following table “AFFECTED ENGINE MODEL AND SERIAL NUMBERS”. This listing includes engines assembled in 1999 utilizing crankshaft processed during calendar year 1998.
2. Your engine is a TCM GTSIO-520-C, D, F, G, H, K, L, M, N or GIO-550-A series engine that had a 1998 TCM manufactured new crankshaft installed during field overhaul or repair. See “CRANKSHAFT SERIAL NUMBER IDENTIFICATION” on page three (3) for means of identifying affected crankshafts.

**Note:** Rebuilt engines assembled utilizing rebuilt crankshafts processed between January 1, 1998 and December 31, 1998 may not contain the “98” identification as a part of the crankshaft serial number. These affected engines are identified by engine model and engine serial number in the following tabular listing and must comply with this Critical Service Bulletin.

**AFFECTED ENGINE MODELS and SERIAL NUMBERS**

ENGINE MODEL	SERIAL NUMBER
GTSIO-520-D	219475 thru 219477
GTSIO-520-H	267476 thru 267490 267492 thru 267499 607111, 607112, 817501 thru 817504, 817512
GTSIO-520-L	292307 thru 292318 292320 thru 292331 292333, 292336 thru 292366, 292368, 292369, 292371 thru 292380

ISSUED			REVISED			 <b>TELEDYNE CONTINENTAL MOTORS</b> An Allegheny Teledyne Company P.O. Box 90 Mobile AL 36601 • 334-438-3411	PAGE NO	REVISION
MO	DAY	YEAR	MO	DAY	YEAR		<b>2 of 13</b>	
07	06	1999					CSB99-6	

GTSIO-520-M	613083, 810618 thru 810625, 810627 thru 810632, 810634 thru 810644, 810646 thru 810649, 810651, 810652, 810657 thru 810666, 810668 thru 810672, 810674
GTSIO-520-N	808311, 808315, 808316, 808318 thru 808320, 808323 thru 808328, 808330 thru 808332, 808334, 808336 thru 808339, 808340, 808343

**Note:** If your engine has recently had a crankshaft installed that may have been manufactured from January 1, 1998 through December 31, 1998, the crankshaft serial number must be verified to determine if this inspection procedure applies. Review engine logbook or maintenance records for the crankshaft serial number installed in your engine. If you are not able to determine the serial number of the crankshaft installed in your engine, you must removed the number 2 cylinder from the engine. Crankshaft serial numbers are located on the number two crankshaft cheek.

**CRANKSHAFT SERIAL NUMBER IDENTIFICATION**

Crankshaft serial numbers incorporate a manufacturing date. Crankshafts produced in 1998 may be identified as follows:

Code:

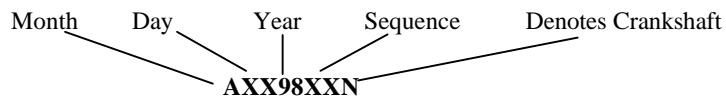

All crankshafts with serial numbers beginning with the letters A through L (Jan. through Dec.) in the first position and the year code 98 in the fourth and fifth position are affected.

ISSUED			REVISED			 <b>TELEDYNE CONTINENTAL MOTORS</b> An Allegheny Teledyne Company P.O. Box 90 Mobile AL 36601 • 334-438-3411	PAGE NO	REVISION
MO	DAY	YEAR	MO	DAY	YEAR		<b>3 of 13</b>	
07	06	1999					CSB99-6	

**GENERAL INFORMATION:**

**INSPECTION OF NEW AND REBUILT AFFECTED ENGINES AND ENGINES THAT HAVE BEEN OVERHAULED OR REPAIRED UTILIZING THE SERIAL NUMBERED CRANKSHAFTS SPECIFIED IN THIS CRITICAL SERVICE BULLETIN.**

**WARNING**

The inspection required by this service bulletin is intended to detect conditions which if present and left uncorrected can result in engine failure.

**PRE-INSPECTION:**

1. a. Turn the master switch Off.
- b. Turn magneto switches Off.
- c. Close the throttle.
- d. Place mixture control in the Idle Cutoff position.
- e. Disconnect the aircraft battery.
2. Remove the engine cowling in accordance with the aircraft manufacturer's maintenance manual to gain access to the engine.
3. Disconnect all spark plug leads from spark plugs to prevent engine firing.
4. Disconnect and remove the starter motor from the starter adapter. This will facilitate turning the engine through by hand.
5. Remove engine baffling and engine mounted equipment, as required, to facilitate removal of cylinders number one, three and five.

**Note: The alternator does not require removal.**

Remove cylinders number one, three and five in accordance with the applicable engine maintenance manual, overhaul manual or aircraft manufacturer's maintenance manual. **Remove the cylinder only far enough to expose the piston pin. Push the piston pin out of the connecting rod bushing only far enough to release the piston and piston pin from**

**the connecting rod, leaving the piston in the cylinder.**

6. The number one, three and five connecting rods will have to be removed to perform the inspection.

**Note:** Place a clean shop towel through the cylinder opening below the crankshaft to catch any items that may be dropped.

**WARNING**

**Anything dropped in the engine must be removed.**

7. Position the connecting rod to be removed (number one, three or five) at or near top center. See Figure 1.

**Note:** Connecting rod nuts may be secured with cotter pins or they may have Spiralock nuts, which do not have cotter pins. When removing Spiralock nuts, you may find it necessary to tighten the nut slightly to release the self-locking feature. The Spiralock nuts removed to facilitate this inspection may be reinstalled provided there is no mechanical damage to the nut threads and the nut flats are not rounded.

8. Remove, if utilized, the connecting rod nut cotter pins and discard them. Remove the connecting rod nuts.
9. Carefully separate the connecting rod from the connecting rod cap. Support the connecting rod cap while removing the connecting rod from the crankshaft. Repeat this procedure for the other connecting rods. Connecting rod bearing inserts do not require replacement unless damaged.
10. Position the crankshaft so that the rearward (aft) snap rings and plates of each counterweight can be removed. Using a pair of snap ring pliers, remove and discard the two snap rings. Remove the two retaining plates. See Figure 2. Do not discard retaining plates, they will be reinstalled in their original location after completing the inspection. Place masking tape or an equivalent adhesive tape over the counterweight pin bores

ISSUED			REVISED			 <b>TELEDYNE CONTINENTAL MOTORS</b> An Allegheny Teledyne Company P. O. Box 90 Mobile AL 36601 • 334-438-3411	PAGE NO	REVISION
MO	DAY	YEAR	MO	DAY	YEAR		<b>4 of 13</b>	
07	06	1999					CSB99-6	

so that the counterweight pins will not exit the counterweight as the crankshaft is rotated during the visual and ultrasonic inspection. Document the location of the removed counterweight retaining plates. They must be reinstalled in the location from which they were removed

**Note:** Counterweights will not clear the crankcase and cannot be removed from the engine.

**CAUTION**

*Use caution when turning crankshaft with a loose counterweight.*

**DETAILED INSPECTION:**

**A. VISUAL INSPECTION:**

1. Rotate the crankshaft so that the crankshaft cheek to be inspected is positioned as shown in Figure 4. The crankshaft connecting rod journal will be at the 8 o'clock position and the counterweight hanger blades will be at the 11 o'clock and 5 o'clock positions.
2. Using a retrieval magnet, remove the counterweight pins on the crankshaft cheek to be inspected. Document the location of the removed counterweight pins. They must be reinstalled in the location from which they were removed. See Figure 3.
3. Position counterweights as shown in Figure 4.
4. Using a soft shop towel dampened with solvent, remove any surface residue from the aft side of crankshaft cheek being inspected. The outboard area at the edge of crankshaft cheek next to the counterweight is the area to be inspected
5. Using a flashlight and mirror or a borescope visually inspect the aft side of the number two crankshaft cheek for indications of a crack or mechanical damage. The inspection area is between the counterweight blade bushing holes at the chamfered edge of blade shoulder on both sides of the crankshaft cheek aft face. See Figure 4.
6. If visual inspection reveals a crack the engine must be removed from service until repaired or replaced.

7. If the visual inspection does not clearly reveal a crack, perform an ultrasonic inspection of the aft side of the number two crankshaft cheek in accordance with Section "B" ULTRASONIC INSPECTION.
8. Reinstall the number 2 crankshaft cheek counterweights and install the counterweight pins in their original location. Place masking tape over the counterweight pin holes before rotating the crankshaft to inspect the number 5 and 8 crankshaft cheeks.
9. Repeat steps 1 (one) through 8 (eight) for crankshaft cheeks five and eight.

**B. ULTRASONIC INSPECTION:**

The ultrasonic inspection must be performed in accordance with TCM procedure MHS 244.

This procedure must be accomplished utilizing the test equipment specified in MHS 244. Personnel performing the ultrasonic inspection must meet the training and experience requirements specified in TCM MHS-244. Deviations from this procedure must be approved in writing from TCM. If a crack or a crack indication is detected during this inspection, the engine must be removed from service until repaired or replaced.

**C. SERVICE SPARE CRANKSHAFTS:**

1. Uninstalled service spare crankshafts must have the visual and ultrasonic inspections performed in accordance with sections A and B of this Critical Service Bulletin. Additionally, perform a magnaflux inspection in accordance with ASTM E 1444. The wet continuous method utilizing full wave rectified alternating current and fluorescent particles is required.
2. Crankshafts meeting the inspection criteria in "C" part 1 must be identified by highlighting the crankshaft serial number with white Dykem.
3. Complete and sign a FAA approved maintenance release document indicating compliance with CSB 99-6.

**RETURN TO SERVICE:**

1. Ensure that no debris is left in the engine interior.

ISSUED			REVISED			 <b>TELEDYNE CONTINENTAL MOTORS</b> An Allegheny Teledyne Company P.O. Box 90 Mobile AL 36601 ☎4-438-3411	PAGE NO	REVISION
MO	DAY	YEAR	MO	DAY	YEAR		<b>5 of 13</b>	
07	06	1999					CSB99-6	

**WARNING**

**Failure to remove all debris from the engine interior can result in engine damage and possible failure.**

2. Install the counterweight pins and retainers in the exact locations from which they were removed.

**CAUTION**

*The snap rings and retainer plates must be installed as shown in Figure 5.*

3. Visually and dimensionally inspect all snap rings to insure the snap ring is correctly installed and fully seated in its groove. See Figure 5.
4. Drain the engine oil into an approved container.
5. Apply 50-weight Aviation grade oil to the number one, three and five crankshaft connecting rod journals and bearing inserts.
6. Install the number one, three and five connecting rods, with bearing inserts in place, on their respective crankshaft connecting rod journal. Ensure that the connecting rod and cap position numbers match each other and are facing up when installed.
7. Lubricate the threads of the connecting rod bolts and nuts with clean 50-weight aviation grade oil and thread the nuts onto the bolts.

**Note:** Spiralock nuts are self locking fasteners and thread freely onto the connecting rod bolt.

9. Torque connecting rod nuts to the torque value specified in Table 1.
  - a. For connecting rods using P/N 654490 self-locking connecting rod nut (Spiralock nut), torque to the value specified in Table 1.
  - b. For connecting rods using P/N 631554 castellated nut and P/N631794 bolt, initially torque nut to the specified low limit in Table 1 (from TCM Service Bulletin SB96-7B). If the cotter pin hole in the bolt and the castellations of the nut do not align, set the torque wrench to the specified maximum torque limit and continue to torque the nut until the castellations align or the specified maximum torque limit is reached. If the

specified maximum torque limit is reached before the castellations align with the cotter pin hole in the bolt, the nut will have to be removed and a new nut installed and torqued as specified above.

10. Install new cotter pin in each nut and secure by seating the cotter pin head in nut castellations and bending one leg of the cotter pin up over the con-rod bolt and back toward the head of the cotter pin. Trim leg so that its end is centered with the center of the bolt diameter. Bend the other leg down and trim it so that its end is mid way between the nut base and the nut castellation. See Figure 6
11. Prior to installing number one, three and five cylinders, ensure that the engine interior is free of any debris and tools.
12. Install a new cylinder base "O" ring on each cylinder.
13. Lubricate the exposed portion of the piston and piston pin on each cylinder with clean 50-weight aviation oil.
14. With the aid of an assistant, install number one, three and five cylinders in accordance with the TCM Maintenance Manual, Overhaul Manual and Service Bulletins.
15. Lubricate all cylinder deck stud threads, through bolt threads and nuts with clean 50 weight engine oil prior to installation and torquing.
16. Torque cylinder deck stud nuts and through bolt nuts to the value specified in Table 2 following the torque sequence shown in Figure 7.

**CAUTION**

*Proper cylinder installation requires a multiple step torquing process. Cylinder base stud threads, through bolt threads and nuts must be lubricated with clean 50-weight aviation oil.*

- a. Torque cylinder base nuts to 1/2 of the specified torque value for the fastener.
- b. Torque the cylinder through bolt nuts and cylinder base stud nuts to the specified torque value for the cylinder base stud nuts. Through bolt nuts must be torqued on both sides of the engine.

ISSUED			REVISED			 <b>TELEDYNE</b> <b>CONTINENTAL MOTORS</b> <small>An Allegheny Teledyne Company                      P.O. Box 90 Mobile AL 36601 ☎4-438-3411</small>	PAGE NO	REVISION
MO	DAY	YEAR	MO	DAY	YEAR		<b>6 of 13</b>	
07	06	1999				CSB99-6		

## WARNING

**Failure to torque through bolt nuts on both sides of the engine can result in a loss of main bearing crush, main bearing shift and engine failure.**

- c. Torque through bolt nuts on both sides of the engine to the specified value for the fastener.
- d. On engines which incorporate the 7<sup>th</sup> cylinder deck stud, lubricate threads and install the 7<sup>th</sup> stud cylinder bracket and conical stud nut. Torque the stud nut to the value specified for the fastener. See Table 2. There is no 7<sup>th</sup> stud installed forward of number five cylinder.

**Note:** Through bolt nuts P/N's 634505 and 649496 have been superseded by nut P/N 652541.

Nut P/N 634505 is a flanged 6 point (hex) nut requiring a torque value of 690-710 inch pounds. Nut P/N 649496 is a flanged 6 point (hex) nut requiring a torque value of 790-810. Nut P/N 652541 is a flanged 12-point nut requiring a torque value of 790-810 inch lbs. At engine overhaul all P/N 634505 and 649496 flanged through bolt nuts must be replaced with P/N 652541 flanged 12 point nuts. If replacing P/N 634505 or 649496 nuts in less than a complete set prior to engine overhaul torque nut P/N 652541 to the required value of the original fastener (P/N 634505 or 649496).

- 17. Reinstall all engine components and baffles removed to facilitate this inspection in accordance with the aircraft manufacturer's maintenance manual.
- 18. Remove and replace the engine oil filter. Torque filter to the specified value and safety wire.
- 19. Reinstall the oil sump drain plug with a new gasket. Torque drain plug to the specified torque

value and safety wire. On engines equipped with an oil sump quick drain, close and secure the quick drain in accordance with the applicable instructions.

- 20. Service the engine with the correct type, grade and quantity of oil.
- 21. Install ignition leads on the proper spark plugs and screw on. Torque the ignition lead coupling nuts to 110 to 120 inch pounds.
- 22. Perform a complete engine ground run up and ensure the engine meets the manufacturer's specified operating limits.
- 23. Thoroughly inspect the engine for oil and fuel leaks, broken, missing or loose hardware.
- 24. Correct all discrepancies prior to returning the engine and aircraft to service.
- 25. Make a logbook entry indicating compliance with this inspection. The entry must include the crankshaft serial number.

### WARRANTY

TCM will allow 26 man-hours of labor per engine to comply with this service bulletin.

Warranty claims for labor and material used to comply with this Critical Service Bulletin must be submitted to:

Teledyne Continental Motors  
P.O. Box 90  
Mobile, AL 36601  
Attn.: Warranty Administration CSB99-6

All warranty claims must have a copy of the repair work order attached. Failure to attach a copy of the repair work order will delay the processing of your warranty claim.

ISSUED			REVISED			 <b>TELEDYNE CONTINENTAL MOTORS</b> <small>An Allegheny Teledyne Company P.O. Box 90 Mobile AL 36601 ☎4-438-3411</small>	PAGE NO	REVISION
MO	DAY	YEAR	MO	DAY	YEAR		7 of 13 CSB99-6	
07	06	1999						

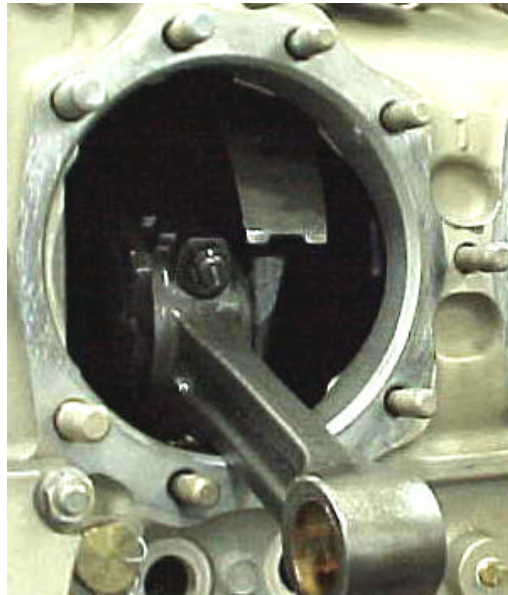

FIGURE 1  
CONNECTING ROD IN POSITION TO REMOVE COTTER PIN, NUTS AND ROD

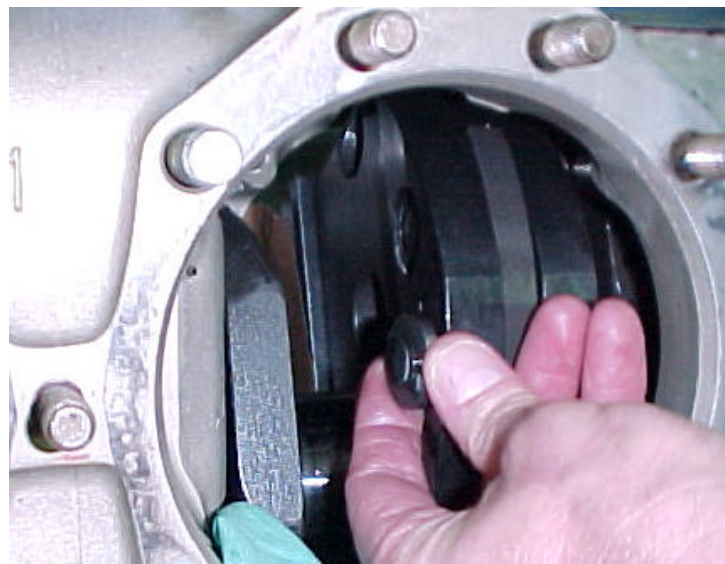

FIGURE 2  
COUNTERWEIGHT RETAINING PLATE REMOVAL

ISSUED			REVISED			 <b>TELEDYNE</b> <b>CONTINENTAL MOTORS</b> An Allegheny Teledyne Company P.O. Box 90 Mobile AL 36601 • 334-438-3411	PAGE NO	REVISION
MO	DAY	YEAR	MO	DAY	YEAR		8 of 13	
07	06	1999				CSB99-6		



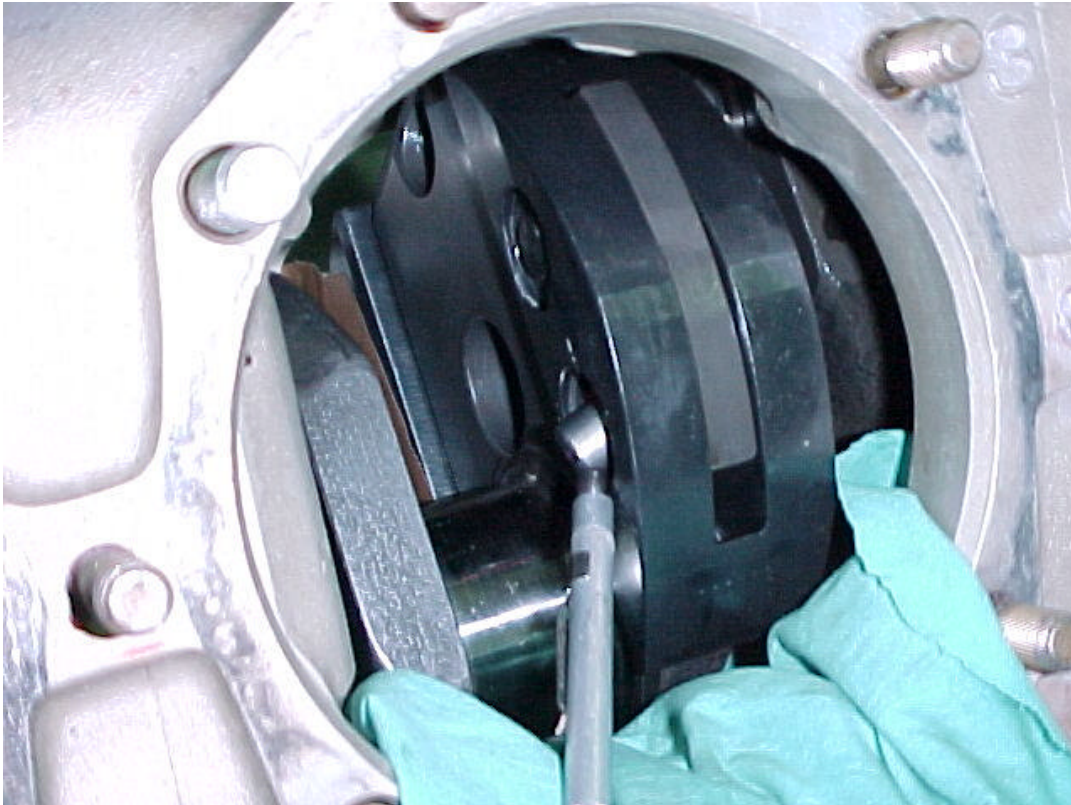

FIGURE 3  
REMOVING COUNTERWEIGHT PINS

ISSUED			REVISED			 <b>TELEDYNE CONTINENTAL MOTORS</b> An Allegheny Teledyne Company P.O. Box 90 Mobile AL 36601 • 334-438-3411	PAGE NO	REVISION
MO	DAY	YEAR	MO	DAY	YEAR		9 of 13 CSB99-6	
07	06	1999						

© TELEDYNE INDUSTRIES, INC. 1999

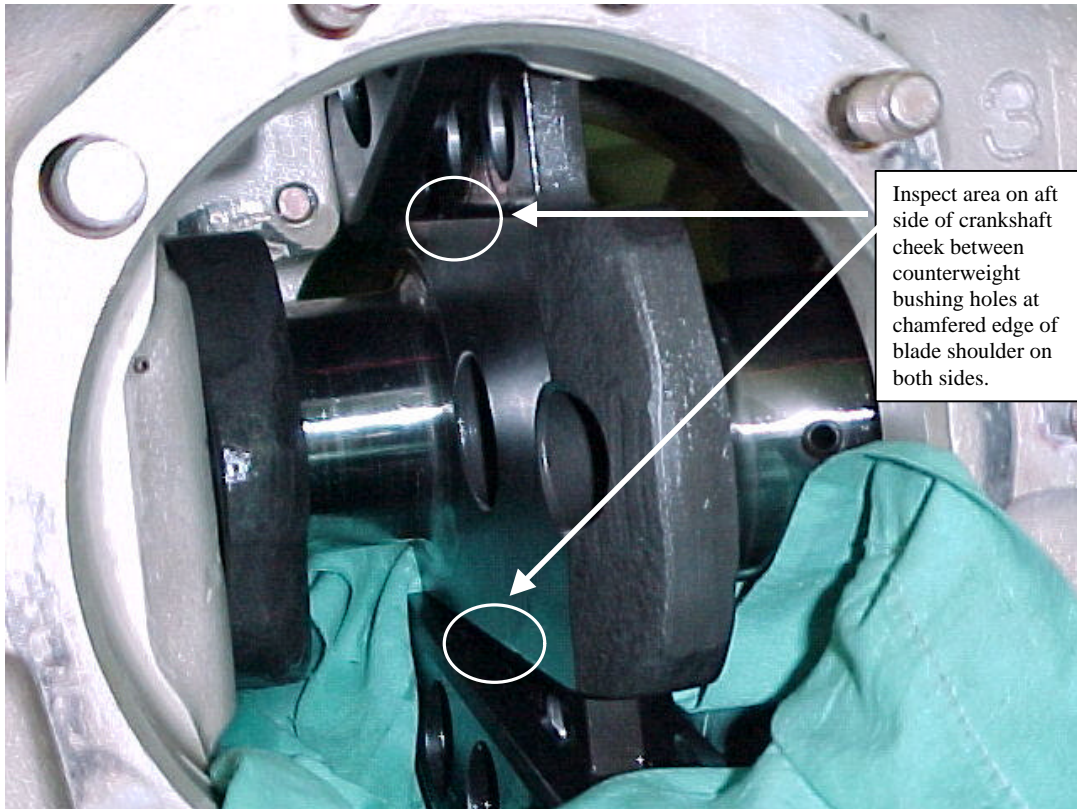

FIGURE 4  
 COUNTERWEIGHTS POSITIONED FOR VISUAL AND ULTRASONIC INSPECTION  
 (VISUALLY INSPECT CIRCLED AREA FOR CRACK INDICATIONS)

ISSUED			REVISED			 <b>TELEDYNE CONTINENTAL MOTORS</b> An Allegheny Teledyne Company P.O. Box 90 Mobile AL 36601 • 334-438-3411	PAGE NO	REVISION
MO	DAY	YEAR	MO	DAY	YEAR		10 of 13 CSB99-6	
07	06	1999						

TELEDYNE INDUSTRIES, INC. 1999

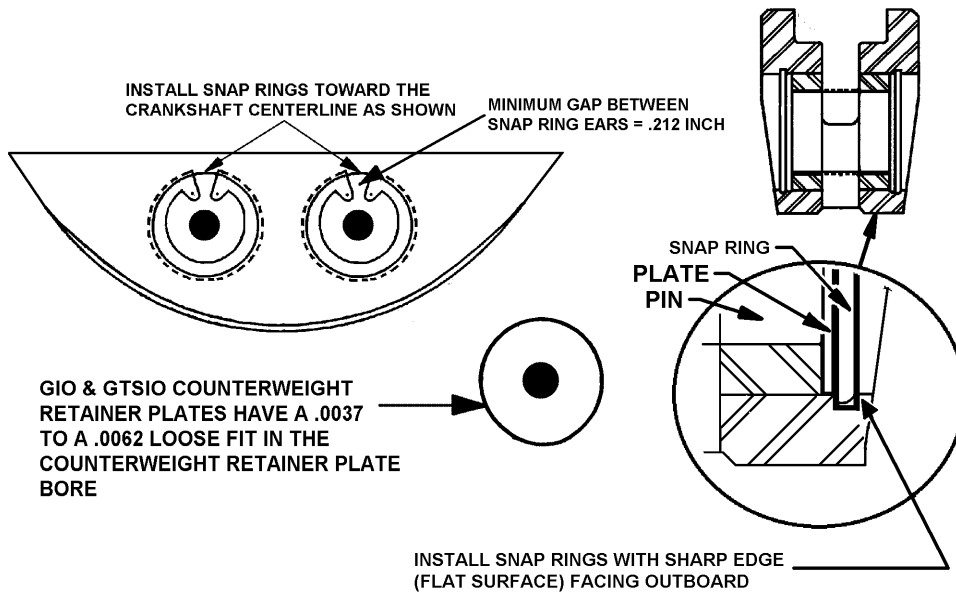

FIGURE 5

COUNTERWEIGHT RETAINER PLATE AND SNAP RING INSTALLATION

**Note:** Use an inspection mirror and flashlight to verify that the entire circumference of each snap ring is fully seated in the counterweight snap ring groove.

ISSUED			REVISED			 <b>TELEDYNE CONTINENTAL MOTORS</b> An Allegheny Teledyne Company P.O. Box 90 Mobile AL 36601 • 334-438-3411	PAGE NO	REVISION
MO	DAY	YEAR	MO	DAY	YEAR		11 of 13 CSB99-6	
07	06	1999						

TABLE 1

CONNECTING ROD BOLT TORQUE VALUES

SIZE	FASTENER	TORQUE VALUE		MODELS AFFECTED
		IN/LB.	FT/LB.	
.44-28 7/16-28	Nut-Connecting Rod (rod P/N 646474, bolt P/N 631794 nut 631554)	550-575	45.8-47.9	GTSIO-520 series engines
.44-20 7/16-20	Nut-Connecting rod Spiralock (12 Point Nut P/N 654490 with bolt P/N 654068)	690-710	57.5-59.2	GIO-550, GTSIO-520 series engines

**Note:** P/N 631794 bolt has been superseded by P/N 654068 bolt. P/N 631554 nut has been superseded by P/N 654490. P/N 654068 bolt and P/N 654490 nut must go into service together. Do not intermix nuts and bolts.

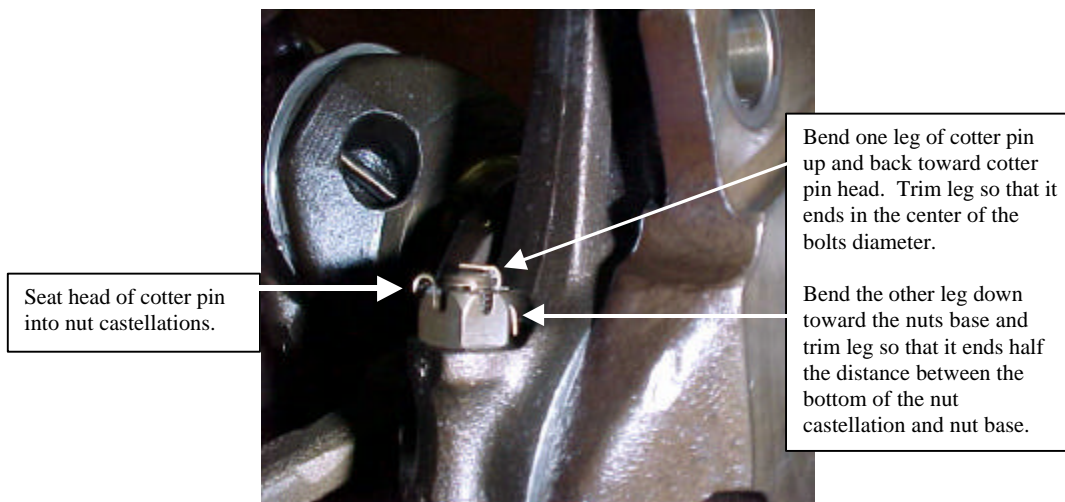

FIGURE 6

COTTER PIN INSTALLTION

FIGURE 7

ISSUED			REVISED			 <b>TELEDYNE CONTINENTAL MOTORS</b> An Allegheny Teledyne Company P.O. Box 90 Mobile AL 36601 • 334-438-3411	PAGE NO	REVISION
MO	DAY	YEAR	MO	DAY	YEAR		12 of 13 CSB99-6	
07	06	1999						

CYLINDER STUD NUT AND THROUGH BOLT NUT TORQUE SEQUENCE

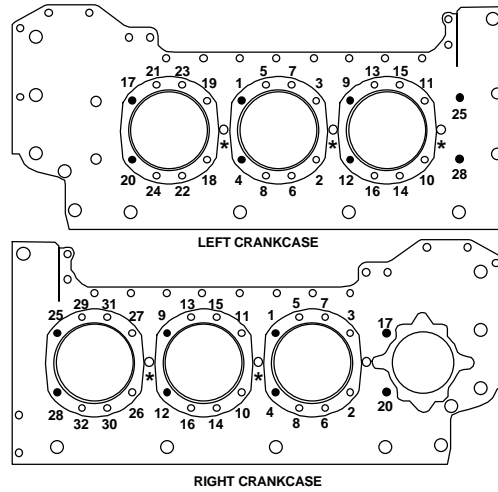

- DESIGNATES CRANKCASE CYLINDER HOLD DOWN THROUGH BOLTS. ALL CYLINDER BASE STUD THREADS AND NUTS AND ALL THROUGH BOLT THREADS & NUTS MUST BE LUBRICATED WITH CLEAN 50 WT AVIATION OIL AND TORQUED TO THE SPECIFIED VALUE IN TABLE 2.
- \* TORQUE 7TH STUD NUT LAST

GTSIO-520 SERIES CYLINDER TORQUE SEQUENCE

TABLE 2

CYLINDER BASE STUD NUT AND THROUGH BOLT NUT TORQUE VALUES

SIZE	FASTENER	TORQUE VALUE		MODELS AFFECTED
		IN/LB.	FT/LB.	
.44-20	Nut-Cyl. to crankcase studs.(includes 7th stud)	490-510	40.8-42.5	All models (except TSIOL-550)
.50-20	Nut-Thru bolt at cad plated washer	615-635	51.2-52.9	IO-346, O-470, IO-470, TSIO-470, GIO-470, IO-520, L/TSIO-520, GTSIO-520, IO-550, TSIO-550, GIO-550
.50-20	Nut-6 Point-Thru bolt at cylinder flange (P/N 634505 .33 in. high)	690-710	57.5-59.2	IO-346, All 470, 520, 550, (Except TSIOL-550)
.50-20	Nut-12 Point-Thru bolt at cylinder flange (P/N 652541)	790-810	65.8-67.5	IO-346, All 470, 520 & 550.

ISSUED			REVISED			<b>TELEDYNE CONTINENTAL MOTORS</b> An Allegheny Teledyne Company P.O. Box 90 Mobile AL 36601 • 334-438-3411	PAGE NO	REVISION
MO	DAY	YEAR	MO	DAY	YEAR		13 of 13 CSB99-6	
07	06	1999						